



Ultima[®]/Ultima[®] X Series Controller and Calibrator

instruction manual

WARNING

THIS MANUAL MUST BE CAREFULLY READ BY ALL INDIVIDUALS WHO HAVE OR WILL HAVE THE RESPONSIBILITY FOR USING OR SERVICING THESE PRODUCTS. Like any piece of complex equipment, the units will perform as designed only if installed, used and serviced in accordance with the manufacturer's instructions. OTHERWISE THEY COULD FAIL TO PERFORM AS DESIGNED AND PERSONS WHO RELY ON THESE PRODUCTS FOR THEIR SAFETY COULD SUSTAIN SEVERE PERSONAL INJURY OR DEATH.

The warranties made by Mine Safety Appliances Company with respect to these products are voided if the products are not used and serviced in accordance with the instructions in this manual. Please protect yourself and others by following them. We encourage our customers to write or call regarding this equipment prior to use or for any additional information relative to use or repairs.

In the U.S., to contact your nearest stocking location, dial toll-free 1-800-MSA-INST. To contact MSA International, dial 1-412-967-3354.

© MINE SAFETY APPLIANCES COMPANY 2003 - All Rights Reserved

This manual is available on the internet at www.msanet.com

Manufactured by
MSA INSTRUMENT DIVISION
P.O. Box 427, Pittsburgh, Pennsylvania 15230

(L) Rev 9

813379

MSA Permanent Instrument Warranty

- 1. Warranty-** Seller warrants that these products will be free from mechanical defect or faulty workmanship for a period of eighteen (18) months from date of shipment or one (1) year from installation, whichever occurs first, provided it is maintained and used in accordance with Seller's instructions and/or recommendations. This warranty does not apply to expendable or consumable parts whose normal life expectancy is less than one (1) year such as, but not limited to, non-rechargeable batteries, filament units, filter, lamps, fuses etc. The Seller shall be released from all obligations under this warranty in the event repairs or modifications are made by persons other than its own or authorized service personnel or if the warranty claim results from physical abuse or misuse of the product. No agent, employee or representative of the Seller has any authority to bind the Seller to any affirmation, representation or warranty concerning the product. Seller makes no warranty concerning components or accessories not manufactured by the Seller, but will pass on to the Purchaser all warranties of manufacturers of such components. **THIS WARRANTY IS IN LIEU OF ALL OTHER WARRANTIES, EXPRESSED, IMPLIED OR STATUTORY, AND IS STRICTLY LIMITED TO THE TERMS HEREOF. SELLER SPECIFICALLY DISCLAIMS ANY WARRANTY OF MERCHANTABILITY OR OF FITNESS FOR A PARTICULAR PURPOSE.**
- 2. Exclusive Remedy-** It is expressly agreed that Purchaser's sole and exclusive remedy for breach of the above warranty, for any tortious conduct of Seller, or for any other cause of action, shall be the repair and/or replacement at Seller's option, of any equipment or parts thereof, which after examination by Seller is proven to be defective. Replacement equipment and/or parts will be provided at no cost to Purchaser, F.O.B. Seller's Plant. Failure of Seller to successfully repair any nonconforming product shall not cause the remedy established hereby to fail of its essential purpose.
- 3. Exclusion of Consequential Damage-** Purchaser specifically understands and agrees that under no circumstances will seller be liable to purchaser for economic, special, incidental or consequential damages or losses of any kind whatsoever, including but not limited to, loss of anticipated profits and any other loss caused by reason of nonoperation of the goods. This exclusion is applicable to claims for breach of warranty, tortious conduct or any other cause of action against seller.

Table of Contents

Section 1	
General Information	1-1
The Ultima/Ultima X Calibrator	1-1
Three Function Operation	1-1
Figure 1-1.	
Ultima Calibrator	1-1
To Operate:	1-2
The Ultima/Ultima X Controller	1-2
Figure 1-2. Pointing the Calibrator	
at the Ultima Gas Monitor Display	1-2
Figure 1-3. Ultima/Ultima X Controller	1-2
Setting up the Controller	1-3
Using the ID CODE Feature	1-3
To Enable or Change the Password ID	1-3
To Disable the Password ID	1-3
Turning the Controller ON	1-4
Turning the Controller OFF	1-4
Setting the Controller for an Ultima or Ultima X Series Instrument	1-4
Setting the Internal TIME of the Controller	1-5
Setting the Internal DATE of the Controller	1-5
When Sending a Command to the	
Ultima/Ultima X Series Gas Monitor	1-6
Note on Resetting latched Alarms	1-6
Section 2	
Calibration	2-1
Equipment Required	2-1
▲ WARNING	2-2
Span Gas Values	2-2
▲ WARNING	2-2
Table 2-1. Factory-set Span Values	2-3
Figure 2-1. Calibration Kit 40 Contents	2-4
Figure 2-2. Calibration Kit 41 Contents	2-5
Table 2-2. Calibration Guide for	
for Combustible Gas Sensor	2-6

Table of Contents

Ultima/Ultima X Series Gas Monitor Calibration	2-8
▲ WARNING	2-8
INITIAL Calibration	2-9
Regular Calibration	2-10
Zeroing	2-10
Spanning	2-12
Figure 2-3. Ultima Unit Apply SPAN Gas Flag	2-12
Figure 2-4. Ultima X Unit Apply SPAN Gas Flag	2-12
Figure 2-5. Span Set-up (Ultima unit shown)	2-13
Figure 2-6. Ultima X Series Unit Calibration End Display	2-14
Figure 2-7. Span Gas Connection (Ultima unit shown)	2-14
OXYGEN Calibration	2-15
25% Oxygen Ultima/Ultima X Series Gas Monitor	2-15
XIR Calibration	2-16

Section 3 Controller - Detailed Operation 3-1

Viewing the Ultima Gas Monitor Display Modes	3-1
Table 3-1. (see "Procedures")The Controller Can Change the Display to Show:	3-1
To View the Status of the Monitor	3-2
Procedures	3-3
Procedure 1. Setting the Average Time Interval	3-3
To Change the Average Time Interval	3-3
Procedure 2. Setting the Span Value	3-4
To Change the Calibration Span Gas Value of the Sensor	3-4
To Change the Calibration Span Gas Value of the Ultima X Series Sensor	3-6
Procedure 3. Setting the Range on an Ultima X Series Sensor	3-6
Procedure 4 Setting the Gas Table for the Ultima XIR Sensor	3-7
Procedure 5. Setting the Three Ultima Gas Monitor Alarm Setpoint Values	3-8
Setting the Three Ultima X Series Gas Monitor Alarm Setpoint Values	3-9
To set the three levels of alarm:	3-9
Enabling/Disabling and Setting the Mode of the Three Ultima Alarm Setpoints	3-10

Enabling/Disabling and setting the Mode of the
Three Ultima X Series Alarm Setpoints 3-11

Procedure 6. Setting the Current Time 3-12
 To update the Ultima Gas Monitor internal clock: 3-12

Procedure 7. Setting the Current Date 3-13
 To update the Ultima Gas Monitor internal date 3-13

Procedure 8. Enabling/Disabling Ultima Gas Monitor
Calibration Output Signal 3-13

Procedure 9. Setting the Number of Days
Between Ultima Gas Monitor Auto-calibration Periods 3-14
 Setting the Time that Ultima Gas Monitor
 Auto-calibration is to begin 3-15

Procedure 10. Setting the Date of the
Next Scheduled Ultima Gas Monitor Calibration 3-15

Procedure 11. Changing the MUX Address 3-16

Procedure 12. Viewing the Previous Successful Calibration Date ... 3-16

Procedure 13. Calibrating/
Checking the 4-20 mA Ultima X Series Outputs 3-17

Procedure 14. Resetting the Ultima X Series Monitors 3-17

Procedure 15. Setting the Alert Option
on an Ultima X Series Sensor 3-18
 Table 3-2. Alert Operation Settings 3-18

Procedure 16. Setting the Sensor Swap Delay
on an Ultima X Sensor 3-19

Programming the Controller 3-19

Removing Existing Programs 3-19

Adding a New Program 3-20

Linking or Combining Programs 3-20
 To Link Programs 3-20
 To Use Programs 1 through 8 3-21
 To use Program #9 3-21
 To use Program #0 3-21

**Section 4
Maintenance 4-1**

▲ WARNING 4-1

Batteries 4-1

Determining a Low Battery Condition on the Ultima Controller 4-1
 To Determine if Battery Replacement is Necessary 4-1

Replacing the Batteries 4-1

Table of Contents

To Install New Batteries in the Ultima Controller	4-1
Determining a Low Battery Condition on the Ultima Calibrator ...	4-2
To Install New Batteries in the Ultima Calibrator	4-2
Service	4-3
▲ WARNING	4-3
Troubleshooting Guidelines	4-3

Section 1 General Information

This manual describes the operation and use of the Ultima Controller and Ultima Calibrator for the Ultima Gas Monitor and the X Series Gas Monitors. It is strongly recommended that this entire manual be read before using the controller or the calibrator.

The controller and calibrator use an Infrared (IR) LED to transmit to an IR receiver in the Ultima/Ultima X Series Gas Monitor.

The Ultima/Ultima X Calibrator (FIGURE 1-1):

- Is a hand-held, self-contained unit powered by two internal AAA batteries
- Allows one person, nonintrusive calibration of an Ultima/Ultima X Series Gas Monitor, enabling the Monitor to be calibrated at the unit without opening the enclosure
- Is listed as Intrinsically Safe for Classification I, Groups B, C, and D, Division 1, Hazardous Locations by UL (reference file #E117653)
- Can select the multiplex address of an Ultima/Ultima X Series Gas Monitor set up in the multiplex mode (if your monitor is so equipped)
- Requires no adjustments
- Features simple, three-button operation
- Provides Auto power ON/OFF.

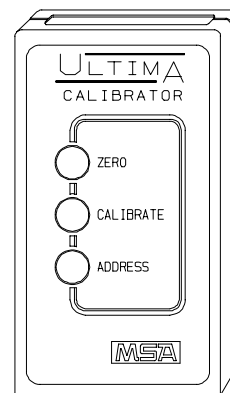

*Figure 1-1.
Ultima Calibrator*

Three Function Operation

The Ultima Calibrator is equipped with three buttons for the following functions:

1. ZERO Button:
 - Performs a zero function on the Ultima/Ultima X Series Gas Monitor; periodically, the monitor may require only a zero adjustment.

2. CALIBRATE Button:
 - Performs a zero and span calibration function on the Ultima/Ultima X Series Monitor; During a complete calibration, the Ultima Gas Monitor requires both a zero and span check gas.
3. ADDRESS Button:
 - Displays or changes the multiplex address on the Ultima/Ultima X Series Monitor, if so equipped.

To Operate:

- All Ultima Calibrator operations are performed by simply pointing the Calibrator at the Ultima/Ultima X Series Gas Monitor display from a distance of no greater than six inches (FIGURE 1-2).

Communication to the Ultima/Ultima X Series Gas Monitor is made via a one way, digitally encoded IR link to ensure tamper-proof and reliable nonintrusive communication.

The Ultima/Ultima X Controller
(FIGURE 1-3):

- Allows non intrusive calibration of an Ultima/Ultima X Series Gas Monitor, enabling the Monitor to be calibrated at the unit without opening the enclosure
- Is a hand-held, self-contained unit powered by two internal AA batteries
- Is certified as Intrinsically Safe for Classification I, Groups B, C and D, Division 1, Hazardous Locations by UL (reference file #E117653)

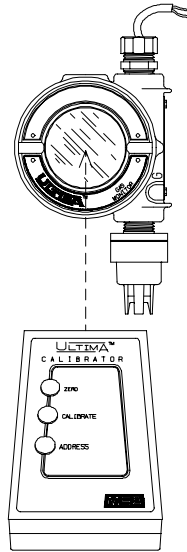

*Figure 1-2.
Pointing the Calibrator at the
Ultima Gas Monitor Display*

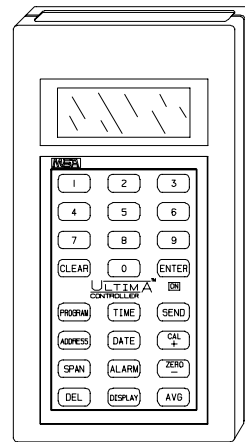

*Figure 1-3.
Ultima/Ultima X
Controller*

- Can select the following on an Ultima/Ultima X Gas Monitor:
 - Set Monitor time and date
 - Set the average interval
 - Set/display span gas value
 - Set/display alarms
 - Display minimum, maximum, and average gas readings
 - Enable calibration output signal
 - Configure auto-calibration feature
 - Display previous calibration date
 - Set/display address
 - Mimic Calibrator
 - Set/Display Range (Ultima X Series units only)

Setting up the Controller

Using the ID CODE Feature

Controller operation can be password-protected to prevent operation by unauthorized personnel. All Ultima Controller units are shipped from the factory with Password ID disabled.

To Enable or Change the Password ID

1. With the unit OFF, press and hold the ENTER button for approximately five seconds, until the display prompts: **ID KEY #####**.
2. Use the NUMBER buttons:
 - To CHANGE password ID by entering the old ID number (go to step 3)
 - To ENABLE a password ID by entering 9999.
3. Press the ENTER button.
 - The display prompts: **NEW KEY #####**.
4. Enter the desired four-digit ID and press the ENTER button.
 - The unit enters the READY mode and saves the ID password required for future operation.

To Disable the Password ID

1. With the unit OFF, press and hold the ENTER button until the display prompts: **ID KEY #####**.
2. Using the NUMBER buttons, enter the old ID number.

3. After entering the four-digit number, press the ENTER button.
 - The display prompts: **NEW KEY ####**.
4. Enter 9999 and press the ENTER button.
 - The unit enters the READY mode and disables the password ID function for future operation.

NOTE: If the ID password is set and forgotten, contact an MSA service representative.

Turning the Controller ON

Press the ENTER button.

- Unit performs a self-test and displays the firmware version for several seconds
- If unit displays the **Ultima READY** or **UltimaX READY** prompt, it is ready for use
- If unit displays the **ID CODE** prompt, enter the user-selected password ID (see "Using the ID CODE Feature").

Turning the Controller OFF

- The unit turns OFF automatically approximately 100 seconds after the last button is pressed
- To manually turn OFF the unit, press and hold the CLEAR button for five seconds.

NOTE: A dual beep tone sounds when CLEAR button is pressed.

Setting the Controller for an Ultima or Ultima X Series Instrument

The Ultima Controller features the capability to transmit to both the Ultima and Ultima X Series instruments. To select the target instrument:

1. Turn unit ON to place into the READY mode.
 - Display prompts: **Ultima READY** or **UltimaX READY**. (see "Turning the Controller ON.")
2. Press the DISPLAY button once.
 - Display prompts: **0=ULTMA 1=ULTMX**.
3. Enter "0" to set the controller for an Ultima instrument or "1" to set the controller for an Ultima X Series instrument.

- a. If your entry is valid, the controller will display "**ULTIMA READY**" or "**ULTIMAX READY**".
- b. If your entry is invalid, it will not be accepted. Start this procedure again to change the controller type.

Setting the Internal TIME of the Controller

The Ultima/Ultima X Controller features an internal real time clock for time/date stamping. To set the real time clock:

NOTE: Momentarily pressing the TIME button displays the current hours and minutes. Press the CLEAR button to return to the READY mode.

1. Place unit in the READY mode
 - Display prompts: "**ULTIMA READY**" or "**ULTIMAX READY**". (see "Turning the Controller ON.")
2. Press and hold TIME button until the **HH:MM** prompt appears.
3. Using the NUMBER buttons, enter the current time in 24-hour format (e.g.: 4:00 P.M. = 16:00). (Leading zeros are required.)
 - a. If your entry is valid, press ENTER button to save this time.
 - b. If your entry is invalid, it will not be accepted; re-enter the correct time or press the CLEAR button to cancel and start over.
 - The DEL button allows for correction during entry.

Setting the Internal DATE of the Controller

NOTE: Momentarily pressing the DATE button displays the current date.

1. Place unit in the READY mode.
 - Display prompts: "**ULTIMA READY**" or "**ULTIMAX READY**".
2. Press and hold the DATE button until the **MM-DD-YYYY** prompt appears. (Leading zeros are required.)
3. Enter the current date using the NUMBER buttons.
 - a. If your entry is valid, press ENTER button to save that date.
 - b. If your entry is invalid, it will not be accepted; re-enter date or press the CLEAR button to cancel and start this procedure again.

- The DEL button allows for correction during entry.

When Sending a Command to the Ultima/Ultima X Series Gas Monitor

1. The Controller must be READY prior to any key press.
2. To change any function on the Ultima/Ultima X Series Gas Monitor, point the top of the controller directly at the clear face of the sensor (FIGURE 1-2) and press the desired sequence of controller buttons. (Controller must be pointed at sensor when final button of sequence is pressed.)
 - The top surface of the controller must be within six inches of the sensor face to enable reception
 - Each button pressed is acknowledged by a short beep
 - The CLEAR button is acknowledged by a double beep
 - When invalid responses are entered, the controller resets to the READY mode or re-prompts user for a correct entry.

Note on Resetting latched Alarms

When an Ultima/Ultima X Gas Monitor has an active latched alarm (indicated by a flashing alarm display):

- An infrared (IR) remote device (such as the Ultima Calibrator or Ultima Controller) may be used to reset this alarm.
- If an Ultima/Ultima X Series Gas Monitor has an active latched alarm, the next IR command it receives from a calibration device will reset the latched alarm (if it is not beyond the alarm threshold). The intended IR command will be ignored and interpreted as an 'alarm reset'. When the latching alarm function is inactive, other valid IR commands may be use.

Section 2 Calibration

The Ultima/Ultima X Series Gas Monitor provides non-intrusive calibration through the use of the Ultima Controller/Calibrator.

When calibrating any Ultima/Ultima X Series Gas Monitor which has any accessory attached to it, refer to the accessory manual for complete calibration instructions. Some accessories for the Ultima/Ultima X Series Gas Monitor include:

- Ultima Sampling Module
- Ultima Auto-Cal Module.

While factory calibration is standard practice for the Ultima/Ultima X Series Gas Monitors, it is recommended to perform an INITIAL calibration when first placing the unit into operation. Refer to the "Initial Calibration" portion of this Chapter.

It is good practice to read the appropriate calibration instructions before attempting an actual calibration. Also, identify and become familiar with all of the calibration components. During the calibration, it is necessary to quickly apply the span gas to the unit. Prior connection of the calibration components will aid in ease of unit calibration.

Equipment Required

Two calibration kits (numbered 40 and 41; see FIGURES 2-1 and 2-2) are available from MSA for diffusion Ultima/Ultima X Series Gas Monitors. Kit 40 and 41 are housed in a convenient carrying case and contain all items necessary (less gas) for a complete and accurate calibration.

These Kits do not calibrate Ultima Sampling Modules or an Ultima/Ultima X Series unit equipped with a flow cap. For flow or sample module systems, refer to the Ultima Aspirated Sampling Module Manual (P/N 710200) or to the Ultima DC Pump Sampling Module Manual (P/N 710201).

NOTE: The calibration procedure for the sample draw Ultima XE/XA Monitor is the same as the procedure for the diffusion version, except calibration gas is applied to the calibration entry port of the inlet flow block and

the cal kit for pumped units provides a flow matching regulator.

The check or calibration gases can also be carried in the case. See TABLE 2-1 for the appropriate zero and span gas cylinders for your Ultima/Ultima X Series Gas Monitor.

TABLE 2-1 shows the recommended calibration kit for Ultima and Ultima X Series Gas Monitors. Typically, Cal Kit 41 uses 0.25 LPM regulator and a calibration cap to contain the calibration gas. Cal Kit 40 uses a 1.5 LPM regulator and no calibration cap. If Cal Kit 41 is recommended and the application is such that the calibration cap cannot be used (such as for a remote sensor application), Cal Kit 40 may be used. However, any time Cal Kit 40 is used, ambient wind conditions must be minimized to avoid a calibration with increased sensitivity.

NOTE: The Ultima XIR uses Cal Kit 40 and does require a calibration cap. This calibration cap (P/N 10041533) is shipped with the product.

⚠ WARNING

These calibration kits contain zero caps to use in place of zero calibration gas. These caps can only be used when the ambient air does not contain the gas the monitor is detecting. If there is any doubt, use zero gas when zeroing the Ultima X Monitor; otherwise, improper calibration could occur.

Span Gas Values

The Ultima/Ultima X Monitor is factory-shipped with a preset span gas value (TABLE 2-1). This span gas value can be changed via the Ultima Controller; otherwise, the span gas must correspond to preset concentrations. See Section 3 to change the span gas value.

The span gas value of Ultima/Ultima X Gas Monitor catalytic combustible models are pre-set to one of the broad categories shown in TABLE 2-1. Specific span gas values for all combustible models are listed under each category given in TABLE 2-2.

⚠ WARNING

Always calibrate for the least sensitive gas or vapor (higher number category) expected to be measured (TABLE 2-2); otherwise, instrument readings may be incorrect.

Table 2-1. Factory-set Span Values				
GAS TYPE	RANGE	SPAN GAS PRESET VALUES	MSA RP CYLINDER P/N	CALIBRATION KIT
CARBON MONOXIDE	0-100 PPM	60 PPM	710882	40
	0-500 PPM	300 PPM	10027938	
SULFUR DIOXIDE	0-25 PPM	10 PPM	10028070	
HYDROGEN SULFIDE	0-10 PPM	5 PPM	710414	
	0-50 PPM	40 PPM	10028062	
	0-100 PPM			
NITRIC OXIDE	0-100 PPM	50 PPM	10028074	
NITROGEN DIOXIDE	0-10 PPM	5 PPM	710332	
CHLORINE	0-5 PPM	2 PPM	710331	
HYDROGEN CYANIDE	0-50 PPM	10 PPM	10028072	
HYDROGEN CHLORIDE ⁽⁵⁾	0-50 PPM	40 PPM	10028060	
CHLORINE DIOXIDE ⁽⁴⁾	0-3 PPM	1 PPM	710331	
OXYGEN	0-5%	5%	493580	40
	0-25%	20.8%	10028028 ⁽²⁾	
NATURAL GAS ⁽³⁾	0-100% LEL	25% LEL(1)	10028034	
PETROLEUM VAPORS ⁽³⁾ (GASOLINE)	0-100% LEL	40% LEL(1)		
GENERAL SOLVENTS ⁽³⁾	0-100% LEL	55% LEL(1)		
NON-METHANE IR	0-100%	29% LEL ⁽¹⁾		
METHANE IR	0-100% LEL	50% LEL ⁽⁶⁾	10028032	
PHOSPHINE	2.0 PPM	0.5 PPM	710533	
ARSINE	2.0 PPM	1.0 PPM		
GERMANE	3.0 PPM	2.5 PPM		
SILANE	25 PPM	5 PPM	10014897	
DIBORANE	50 PPM	15 PPM		
FLUORINE	5.0 PPM	4.0 PPM	710331	
BROMINE	5.0 PPM	2.5 PPM		
AMMONIA	0-50 PPM	25 PPM	10028076	40
HYDROGEN	0-1000 PPM	500 PPM	10022386	
ETO ⁽⁷⁾	0-10 PPM	4.0 PPM	10028070	
CARBON DIOXIDE IR	0-2%	1.5%	807386	
NOTES:				
¹ CALIBRATED WITH PROPANE (.6% GAS BY VOLUME)				
² NOT REQUIRED FOR STANDARD CALIBRATION PROCEDURE				
³ FOR COMBUSTIBLE GAS, IT IS GOOD PRACTICE TO CALIBRATE UNIT WITH GAS TO BE DETECTED				
⁴ ClO ₂ IS CALIBRATED WITH Cl ₂ OR USE ClO ₂ CALIBRATOR KIT (P/N 710420)				
⁵ HCL IS CALIBRATED WITH H ₂ S				
⁶ METHANE IR IS CALIBRATED WITH 50% LEL METHANE.				
⁷ ETO IS CALIBRATED WITH SO ₂ .				

Section 2, Calibration

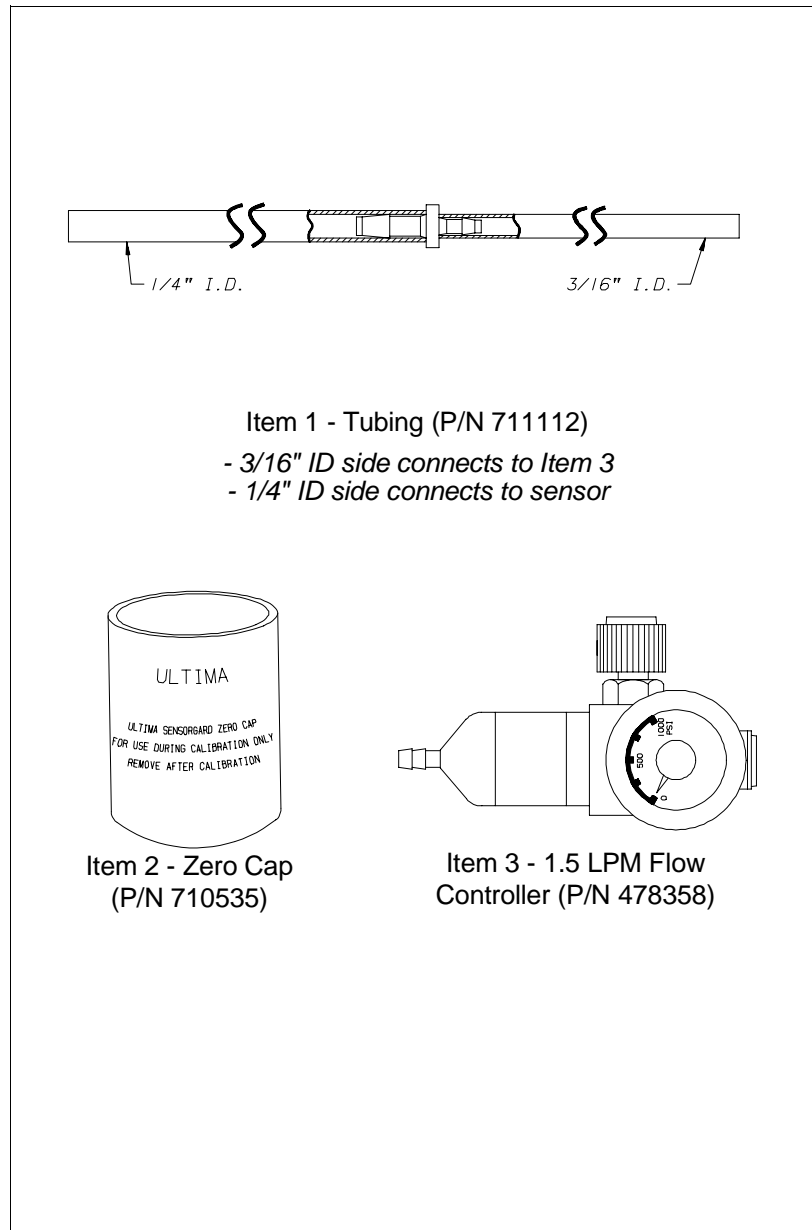

Figure 2-1. Calibration Kit 40 Contents
(Your Kit may also include one or two gas cylinders)

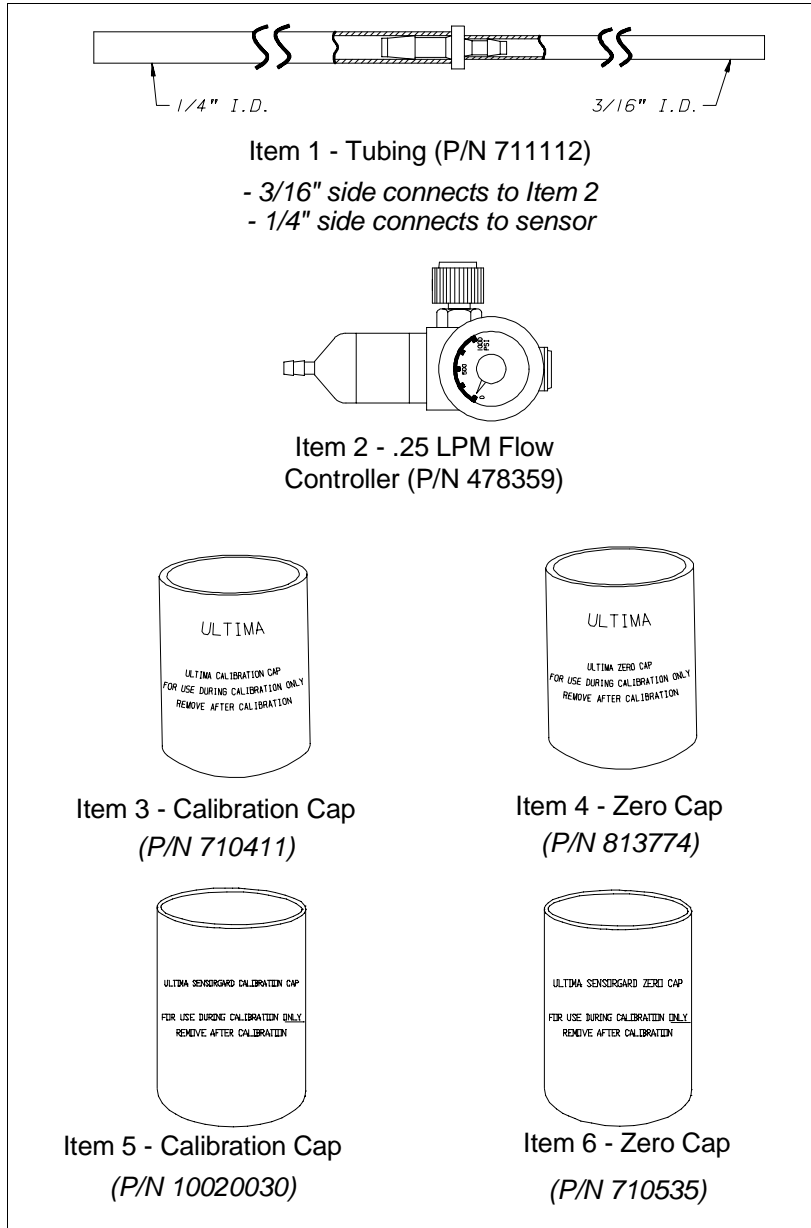

Figure 2-2. Calibration Kit 41 Contents
(Your Kit may also include one or two gas cylinders)

Section 2, Calibration

Table 2-2. Calibration Guide for Combustible Gas Sensor			
CATEGORY 31: FOR CATALYTIC TYPE 1S NATURAL GAS			
To detect the following gases, recalibrate with 0.6% propane and set the span gas value accordingly:			
Acetaldehyde	23	Hydrogen	16
Acetylene	24	MAPP Gas	20
Butadiene, 1, 3	25	Methane	20
Carbon Monoxide	20	Methanol	20
Ethane	24	Methylene Chloride	24
Ethylene	25	Monomethyl Amine	22
Ethylene Dichloride	22	Trigonox B	22
CATEGORY 32: FOR CATALYTIC TYPE 1S PETROLEUM VAPORS			
To detect the following gases, recalibrate with 0.6% propane and set the span gas value accordingly:			
1, 1, 1-Trichloroethane	32	Ethylene Oxide	36
Acetic Acid	28	Freon 152A	28
Acetone	37	Gasoline	35
Acrolein	28	Hexane	40
Acrylonitrile	26	Isoprene	33
Allyl chloride	30	Methyl Acetate	34
Benzene	37	Methyl chloride	32
Butane (n)	36	Methyl Propene (2)	29
Butane (iso)	32	Methyl t-Butyl Ether	35
Butanol (iso)	38	Pentane (n)	36
Butene-1	34	Pentane (iso)	36
Butene-2	37	Pentene	35
Butyl Acetate (n)	28	Propane	29
Butylene	33	Propanol (n)	36
Butyraldehyde	30	Propanol (iso)	37
Chlorobenzene	38	Propylene	33
Cyclohexane	37	Propylene Oxide	33
Dimethoxyethane	26	Tetrahydrofuran	30
Dioxane, 1, 4	39	Toluene	39
Epichlorhydrin	33	Trichloroethylene	35
Ethanol	30	Triethylamine	38
Ether, Diethyl	37	Vinyl Acetate	34
Ether, Dimethyl	30	Vinyl Chloride	32
CATEGORY 33: FOR CATALYTIC TYPE 1S GENERAL SOLVENTS			
To detect the following gases, recalibrate with 0.6% propane and set the span gas value accordingly:			
Amyl alcohol	43	JP-4	41
Butanol (n)	48	Methyl Cellosolve	49
Butyl Acrylate	46	Methyl Ethyl Ketone	52
Cellosolve	42	Methyl Isobutyl Ketone	53
Di isopropylamine	42	Methyl Methacrylate	40
Diethylamine	41	Naphtha, VM&P	53
Ethyl Acetate	43	Octane (iso)	52
Ethyl Acrylate	52	Propyl Acetate	45
Ethyl Benzene	41	Styrene	42
Heptane	42	Xylene	50
Hexene	42		

**Table 2-2.
Calibration Guide for Combustible Gas Sensor**

CATEGORY 34: ULTIMA IR METHANE			
To detect the following gases, recalibrate with 2.5% methane and set the span gas value accordingly:			
Acetone	86	Isoproponal	25
Butadiene, 1, 3	80	MEK	53
Cyclohexane	14	Methane	50
Ethanol	17	Methanol	14
Ethyl Acetate	34	Methyl Formate	13
Ethylene	95	Propylene	39
Heptane	14	Toluene	64
Hexane	14	Xylenes	53
IsoButanol	20		
CATEGORY 35: ULTIMA IR NON-METHANE			
To detect the following gases, recalibrate with 0.6% propane and set the span gas value accordingly:			
Butane	31	IsoButane	33
Butyl Acetate	48	IsoButanol	47
Cyclohexane	37	IsoPropanol	52
Cyclopentane	32	Methanol	27
Dimethyl Ether	25	Methyl Formate	35
Ethane	30	Pentane	31
Ethanol	36	Propane	29
Ethylene Oxide	72	Propyl Acetate	51
Heptane	36	Propyl Alcohol	31
Hexane	37	Propylene Oxide	26
CATEGORY 38: ULTIMA XIR METHANE			
To detect the following gases, recalibrate with 2.5% methane and set the span gas value accordingly:			
Methane	50		
CATEGORY 39: ULTIMA XIR NON-METHANE			
To detect the following gases, recalibrate with the stated % propane and set the span gas value accordingly:			
Butane, .6% propane	28	Hexane .6% propane	41
Cyclopentane, .6% propane	30	Pentane .6% propane	33
Ethane, .6% propane	25	Propane .6% propane	29
Ethylene, .1% propane	28		

Example: If measuring gases or vapors that appear in TABLE 2-2, Category 2 and Category 3, you should calibrate to the Category 3 span value (55% LEL) with .6% propane by volume applied.

If the gas or vapor you are measuring does not appear in the TABLE 2-2 categories, consult MSA 1-800-MSA-INST for the proper setting. If you wish to calibrate to the specific LEL of the gas or vapor being measured, the expected span gas value of the Ultima/Ultima X Series Gas Monitor can be changed by the Ultima Controller.

Ultima/Ultima X Series Gas Monitor Calibration

WARNING

To ensure a fully functional sensor, perform calibration checks and adjustments at initial start-up and at regular intervals.

As with any type of gas monitor, the only true check of its performance is to apply gas directly to the sensor. The frequency of the calibration gas tests depends on the operating time and chemical exposures of the sensors. New sensors should be calibrated more often until the calibration records prove sensor stability. The calibration frequency can then be reduced to the schedule set by the safety officer or plant manager.

In some cases, it may be necessary to perform only a zero function of the Gas Monitor in lieu of a full zero and span procedure. Check with your safety officer or safety engineer to determine if only a zero function is necessary.

NOTES:

- If this is the first calibration or, if the sensor element has been changed or replaced, see Section 2, "Initial Calibration."
- If this is an oxygen sensor, see Section 2, "Oxygen Calibration."
- If this is an XIR sensor, see Section 2, "XIR Calibration."
- Apply power to the unit at least 1 hour before calibrating.
- Due to the unstable nature of Chlorine Dioxide (ClO₂), Chlorine gas is used as a calibration simulant. If using the MSA calibration system and gas cylinder (P/N 710331), the response ratio is 2:1. In other words, the 2 ppm sample of Chlorine should be set to read 1 ppm of ClO₂. The default value for the

calibration gas on the ClO₂ Ultima/Ultima X Series Gas Monitor is 1 ppm.

- For Cl₂ and ClO₂ calibration, do not mix regulators. Use only one regulator for each of these gases. They will not work properly if one regulator is used for multiple gases.
- Due to the reactivity of HCL with flow system components, H₂S gas can be used as a calibration simulant. If using the MSA calibration system and gas cylinder (P/N 467898, 10 ppm H₂S in Nitrogen) the span value should be set to 40 ppm of HCL (the default span value of HCL).

INITIAL Calibration

When a new sensor is placed in the Ultima Gas Monitor, an **INITIAL** Calibration must be performed. When a new sensor is placed in the *Ultima X* Gas Monitor, an **INITIAL** Calibration is also *recommended*. This procedure enables the unit to gather data about the sensor to make accurate decisions for the **CHANGE SENSOR** function and the **CAL FAULT** function to work properly. Additionally, **INITIAL** Calibration should only be used when a regular calibration will not clear a fault condition due to use of incorrect cal gas or other similar situation.

Initial calibration is accomplished by:

- pressing the **ZERO** and **CALIBRATE** buttons simultaneously on the Ultima Calibrator
- pressing and holding the **SPAN** button on the Ultima Controller
 - The Controller display shows "**Do Init Cal 1=y**"
 - Press 1 while pointing the Controller at the Ultima/Ultima X Series display.
- The Ultima display should show "**SET APPLY ZERO GAS**"
- The Ultima X Series display should show "**APPLY ZERO GAS**"
- The remainder of the procedure is now the same as that for a regular calibration.
- The presence of the words "**SET**" (on Ultima units only) and "**ICAL**" (on both Ultima and Ultima X Series units) on the display distinguish **INITIAL** Calibration from a regular calibration. If the word "**ICAL**" does not appear, the user may abort the calibration by pressing any button on the Calibrator while aiming at the unit; then, retry the above procedure.

NOTE: The calibration process can be aborted at any time during the 30-second countdown simply by pressing

the ZERO, CAL or ADDRESS button on the Controller/Calibrator while aiming at the unit.

- The display leads the user through the zero and span routines as in a regular calibration.

NOTE: This procedure should be initiated only when a new sensor element is installed. Otherwise, the sensor end-of-life indication may not be accurate.

Regular Calibration

A regular calibration includes a "zero" and "span" as described in the following procedures. If the user chooses to only perform a "zero", they may do so by pressing the ZERO button instead of the CALIBRATE or CAL button as described in step 3.

- For oxygen units, skip to Step 3.

Zeroing

1. Using the Zero Cap

If the ambient air is suitable, with no traces of the gas of interest, place the appropriate Calibration Kit zero cap over the SensorGard inlet and wait two minutes; otherwise, use zero gas.

2. Using Zero Gas Cylinder:

- a. Locate the Zero Gas Cylinder and the Calibration Kit Flow Controller.
- b. Screw the Flow Controller onto the top of the Zero Gas cylinder.
- c. Locate the Calibration Kit Tube Assembly.
- d. Push the smaller end of the Tube Assembly over the Flow Controller gas outlet and ensure tubing completely covers the gas outlet.
- e. When using Cal Kit 40, connect the other end of the tubing over the SensorGard inlet.

When using Cal Kit 41 (or Cal Kit 40 with the Ultima XIR), locate the Cal Cap with a hole for tubing and push the tubing through the hole in the bottom of the cap. Then, connect the end of the tubing over the sensor inlet and push the calibration cap over the entire sensor inlet (see FIGURE 2-7).

NOTE: The calibration cap (P/N 10041533) for the Ultima XIR is shipped with the product and is not contained in the calibration kit.

- f. Turn ON the gas flow by turning the knob on the flow controller.
3. Point the Ultima Controller/Calibrator at the Ultima/Ultima X Monitor display and press the Controller/Calibrator CAL/CALIBRATE button.

The display shows:

- A countdown from 30 to 0 seconds
- **APPLY ZERO GAS.**

NOTE: The zero or calibration process can be aborted at any time during the 30-second countdown interval; simply press the ZERO, CAL or ADDRESS button on the Controller/Calibrator while aiming it at the unit.

NOTE: The 30-second countdown interval is omitted for oxygen units. It is electronically zeroed.

4. After the 30 second countdown:
 - The display alternates between "**CAL**" and a value (example: 0 PPM). This value is the actual reading of the gas concentration the sensor is detecting. The engineering units (PPM, % or %LEL) are predetermined by the type of sensor installed and are not changeable.
 - Once the gas value is stable, the alternating display stops. If the calibration is successful, the display will show **END**.
- a. If using the zero cap, remove it.
- b. If using a zero gas cylinder:
 - 1) Turn OFF the gas flow by turning the flow controller knob.
 - 2) Remove the tubing from the Flow Controller.
 - If the calibration output signal is enabled during calibration, it will be held at the lockout value for an additional two minutes or until after the span routine if performing a full calibration.
- c. If a **CAL FAULT** flag appears on the unit, this indicates:
 - An unsuccessful attempt to zero or calibrate the Ultima/Ultima X Series Gas Monitor

- The Ultima/Ultima X Series Gas Monitor is operating with the calibration parameters defined before the calibration was attempted.
- See Troubleshooting Guidelines found in the Ultima manual (P/N 813161) and the Ultima X Series manual (P/N 10036101).

To extinguish the **CAL FAULT** flag, a complete successful calibration procedure must be performed.

The Ultima/Ultima X Series Gas Monitor allows automatic zero adjustment only within a pre-defined range. It cannot make corrections outside this range, such as when an empty or wrong cylinder of gas is applied or failure to begin gas flow within the allotted 30-second countdown occurs.

- If only a ZERO was performed, the procedure is complete and the user should return the calibration equipment to the cal kit. If a CAL was performed, the gas monitor will continue to the "span" sequence as described in the following section.

Spanning

5. During a regular calibration, the Ultima/Ultima X Series Gas Monitor automatically begins the span countdown after a successful zeroing of the unit. The span countdown is 30 seconds (FIGURES 2-3 and 2-4).

- The span process can be aborted at any time during the countdown by simply pressing the ZERO, CAL or ADDRESS button on the Controller/Calibrator while aiming it at the unit.

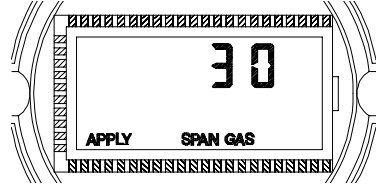

Figure 2-3. Ultima Unit Apply SPAN Gas Flag

6. Locate the span gas cylinder and the Calibration Kit Flow Controller.
7. Screw the Flow Controller onto the top of the span gas cylinder.
8. Locate the Calibration Kit Tube Assembly.

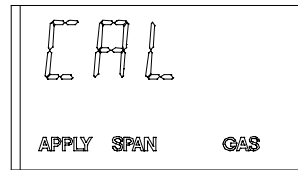
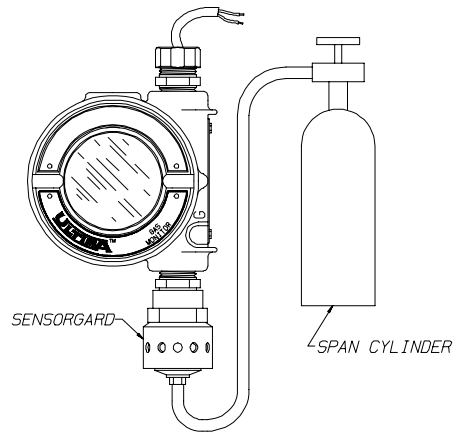

Figure 2-4. Ultima X Unit Apply SPAN Gas Flag

9. Push the smaller end of the Tube Assembly over the gas outlet of the Flow Controller and ensure that the tubing completely covers the gas outlet.



10. When using:

- a. **Cal Kit 40**, connect the other end of the tubing over the SensorGard inlet (FIGURE 2-5).
- b. **Cal Kit 41 (or Cal Kit 40 with the Ultima XIR)**, locate the cal cap with hole for tubing and push the tubing through the hole in the bottom of the cap. Then, connect the end of the tubing over the sensor inlet and push the calibration cap over the entire sensor inlet (see FIGURE 2-7).

Figure 2-5.

Span Set-up (Ultima unit shown)

11. Turn ON the gas flow by turning the flow controller knob.
 - It is good practice to have all calibration components previously assembled.
 - Ensure that any calibration gases are applied during the 30-second count down period.
 - If **CAL FAULT** displays on the Ultima/Ultima X Series Gas Monitor before the user is able to apply the gas, a stable gas condition was reached, causing the unit to use a wrong reading as a span indication.
 - It is necessary to restart the calibration process to clear this condition.
12. After the 30 second countdown:
 - The display alternates between "**CAL**" and a value. (for example: 60 PPM for 0 to 100 ppm carbon monoxide). This value is the actual reading of the gas concentration the sensor is detecting. The engineering units (PPM, % or %LEL) are predetermined by the type of sensor installed and are not changeable.

- Once the gas value is stable, the alternating display stops. If the calibration is successful, the display will show **END** for approximately two seconds. (FIGURE 2-6).

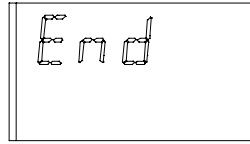

Figure 2-6. Ultima X Series
Unit
Calibration End Display

- No user adjustments are necessary.
 - The display will show the span gas value while the span gas is flowing to the unit. (For example, it may read 60 PPM or 25 % or 60 % LEL).
13. Turn OFF the gas flow by turning the knob on the flow controller.
- If the calibration output signal is enabled during calibration, it will be held at the lockout value for two additional minutes after **END** is displayed.

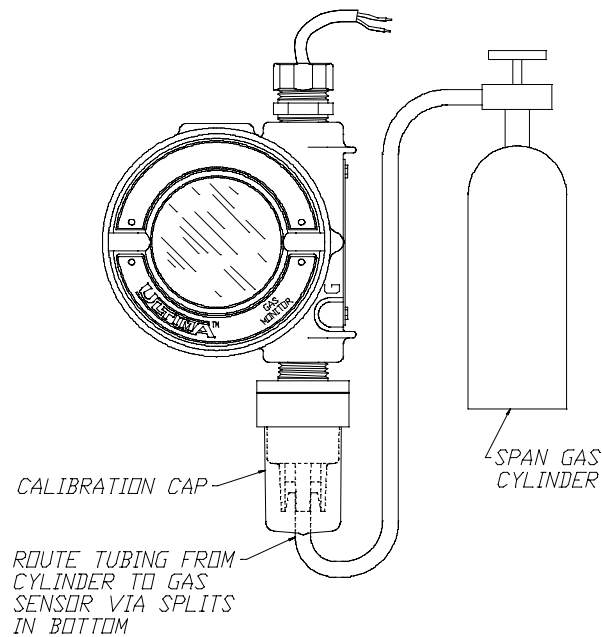

Figure 2-7.
Span Gas Connection (Ultima unit shown)

- When the span gas is removed from the sensor, the sensor reading may take several minutes to return to zero; this is normal sensor operation.
- If a **CAL FAULT** flag appears on the unit, this indicates:
 - An unsuccessful attempt to calibrate the Ultima/Ultima X Series Gas Monitor
 - The Ultima/Ultima X Series Gas Monitor is operating with the calibration parameters defined before the calibration was attempted.

To extinguish the **CAL FAULT** flag, a complete calibration procedure must be performed.

The Ultima/Ultima X Series Gas Monitor allows automatic zero and span adjustments only within a pre-defined range. It cannot make corrections outside this range, such as when an empty or wrong cylinder of gas is applied or failure to begin gas flow within the allotted 30-second countdown occurs.

14. After a successful calibration, remove the tubing from the Flow Controller and remove the Flow Controller from the cylinder; return all items to their appropriate location in the Calibration Kit.

OXYGEN Calibration

NOTE: If this is the first calibration after the sensor element is replaced, perform an "Initial Calibration."

Oxygen calibration is slightly different from other gases. When the **ZERO** function is performed, the 30-second countdown is omitted because the Ultima/Ultima X Series unit performs the zero electronically. No calibration cap or zero gas is necessary.

To meet the specification stated, it is necessary to span the oxygen Ultima/Ultima X Series Gas Monitor with the Calibration Kit and an oxygen cylinder. The concentration of oxygen in air varies slightly due to changing relative humidity and pressure levels. These variations in oxygen levels are detected by the oxygen Ultima/Ultima X Series Gas Monitor. To meet the reproducibility specification, it is necessary to use a calibration gas cylinder. This ensures the same concentration of oxygen for every calibration.

25% Oxygen Ultima/Ultima X Series Gas Monitor

For the **SPAN** function, ambient air is generally adequate *for the 25% oxygen Ultima/Ultima X Series Gas Monitor* as the

expected default span value is 20.8%. Therefore, when the display prompts "**APPLY SPAN GAS**" it would be adequate to simply allow the countdown to occur without applying gas.

NOTE: If the sensor is located in an area of normally low or enriched oxygen, then a 20.8% oxygen sample must be applied when the display prompts: "**APPLY SPAN GAS**".

XIR Calibration

Although a full calibration (zero and span) can be performed on the Ultima XIR Gas Monitor, a no-gas calibration is sufficient to properly calibrate the monitor. A zero adjustment is all that is required for a full calibration. Normally, any degradation of the sensor's performance is associated with slight drifts in its zero response which, in turn, will adversely affect its span performance. Restoring the sensor's zero is typically sufficient to restore its span performance.

A zero adjustment is performed by pressing the ZERO button on the Calibrator or Controller and following the "Zeroing" instructions given earlier in this chapter. After completing the zeroing function, perform a span check to ensure proper operation. If the span check is unsuccessful, perform a full calibration.

NOTE: For calibration of an XIR sensor operating with a Flow Cap, temporarily replace the Flow Cap with the Environmental Guard (packaged with the instrument) and perform the following procedure.

⚠ WARNING

The Calibration Cap must be removed from the XIR environmental guard after completing the Zeroing and/or Spanning procedure; otherwise, the sensor cannot perform properly.

Section 3 Controller - Detailed Operation

Viewing the Ultima Gas Monitor Display Modes

Table 3-1. (see "Procedures") The Controller Can Change the Display to Show:		
DISPLAY	DEFAULT	TO CHANGE, SEE PROCEDURE #
Current gas concentration reading	N/A	N/A
Minimum gas concentration reading over last time average interval	N/A	1
Maximum gas concentration reading over last average time interval	N/A	1
Average gas concentration reading over last average time interval	N/A	1
Time interval for minimum, maximum & average gas reading	1 HOUR	1
Zero gas concentration value	N/A	N/A
Sensor Range	N/A	3
Gas Table Value	1	4
Span gas concentration value	see TABLE 1	2
Alarm 1, 2, 3 setpoints	DISABLED Ultima	5
	ENABLED Ultima X	5
IF ENABLED:		5
Alarm 1	10% full-scale	
Alarm 2	20% full-scale	
Alarm 3	30% full-scale	
Oxygen Alarm 1	19.5%**	
Oxygen Alarm 2	18.0%**	
Oxygen Alarm 3	22.0%	

Table 3-1. (see "Procedures") The Controller Can Change the Display to Show:		
DISPLAY	DEFAULT	TO CHANGE, SEE PROCEDURE #
Current time	EASTERN STANDARD TIME	6
Current date	CURRENT DATE	7
Calibration signal status	OFF	8
Calibration interval and Future calibrate time	30 DAYS & 00:00	9
Future calibrate date	DISABLED*	10
Sensor address (MUX frequency output only)	1	11
Viewing the previous successful calibrate date	N/A	12
Calibrating/checking 4-20 mA (Ultima X only)	N/A	13
Resetting the Ultima X	N/A	14
Alert option (Ultima X only)	OFF	15
Setting Sensor Swap Delay (Ultima X only)	ON	16
* The date is set to 12/31/94, which disables auto-calibration (Ultima only).		
**Indicates negative or downward-acting alarms.		

To View the Status of the Monitor

To view any of the display modes listed above, such as current time or date, perform the following:

1. Turn the unit ON by pressing the ENTER button; wait until the READY prompt displays.
2. Press the SEND button. The display prompts: **SEND?**
3. Press the DISPLAY button.
 - The display prompts: **Sel Dsp Item ±.**
4. Press the + or - button to scroll through the available list as described above.
5. When the desired choice appears on the display, aim the controller at the sensor and press the ENTER button.

NOTE: These readings are only displayed on the Gas Monitor for only *five* seconds. The display then returns to the *actual* gas concentration.

Procedures (see TABLE 3-1)

Procedure 1. Setting the Average Time Interval

The average, minimum and maximum gas concentration values are gathered over the last time interval set by the Controller. This procedure is used to change the time interval used for the average, minimum, and maximum gas concentration value calculations of the Sensor.

To Change the Average Time Interval

1. Press the SEND button.
 - The display prompts: **SEND?**
2. Press the AVG button.
 - The display prompts: **Set Avg Term ±**
3. Press the + or - button to scroll through the available list:
 - Every 1 Hour
 - Every 8 Hours
 - Every 24 Hours.
4. When the desired time interval is displayed, aim the controller at the sensor and press the ENTER button.
 - The Monitor will show the time interval selected for five seconds
 - The Monitor time interval is now set to the desired selection.
 - The Monitor display shows the average, minimum, or maximum gas concentration reading over the selected interval. This reading is updated at the end of the selected average interval.

Procedure 2. Setting the Span Value

Monitors are shipped with TABLE 2-1 default span gas values. MSA calibration cylinders are available for most of these pre-set span gas concentrations; if an alternate span gas value is needed, the Monitor span calibration value must be changed.

To Change the Calibration Span Gas Value of the Ultima Sensor

1. Press the SEND button.
 - The display prompts: **SEND?**
2. Press the SPAN button.
 - The display prompts: **Span Gas Type ±**
3. Press the + or - button to scroll through the available gas list. One of the following gases will correspond to the range of your Ultima Gas Monitor. Check the sensor housing label.

NOTE: If your gas type or range is not shown on the Controller display, you may use the custom range option on the menu.
4. When the selection matching your sensor type is found, press the ENTER button.
 - The display prompts: **SpanVal ###.**

NOTE: If the custom range option was selected, a decimal point may be implied, since this range can be used for decimal point and non-decimal point Ultima units. When sending a value to an Ultima unit that indicates a decimal point, enter the data assuming an implied decimal point (e.g., "009" is interpreted as "00.9").
5. Using the NUMBER buttons, enter the desired three-digit value. (Leading zeros are required.)
 - Corrections can be made using the DEL button.
6. After the value is entered, aim the controller at the sensor and press the ENTER button.
 - The Ultima Gas Monitor will show the new span gas value for five seconds
 - If the span gas concentration value is higher than the full scale range of that gas, the Controller will not send that value to the Ultima Gas Monitor; re-enter a span gas concentration value lower than or equal to full scale value.
 - The Ultima Gas Monitor desired span gas value is now changed to the selected concentration.

To Change the Calibration Span Gas Value of the Ultima X Series Sensor

1. Press the SEND button.
 - The display prompts: **SEND?**
2. Press the SPAN button.
 - The display prompts: **Span Option ±**
3. Press the + or - button until the display prompts: **UltimaX SpanVal**
4. Press the Enter button.
 - The display prompts: **SpanVal ####.##**
5. Using the NUMBER buttons, enter the desired value (ATM style, lagging zeros are required).
6. After the value is entered, aim the controller at the sensor and press the ENTER button.
 - The Ultima X Series Gas Monitor shows the new span gas value.
 - If the span gas concentration value is higher than the full scale range, the Ultima X Series Gas Monitor will display the current span value setpoint.
 - The Ultima X Series Gas Monitor span gas value is now changed to the selected concentration.

Procedure 3. Setting the Range on an Ultima X Series Sensor

1. Press the SEND button.
 - The display prompts: **SEND?**
2. Press the SPAN button.
 - The display prompts: **Span Option ±**
3. Press the + or - button until the display prompts: **UltimaX Range.**
4. Press the Enter button.
 - The display prompts: **Range ####.##**
5. Using the NUMBER buttons, enter the desired value (ATM style, lagging zeros are required).
6. After the value is entered, aim the controller at the sensor and press the ENTER button.
 - The Ultima X Series Gas Monitor will show the new full scale gas value.

- The SPAN (CAL) value must be within the range of the instrument. Therefore, if the combustible sensor is calibrated at 55% LEL, the instrument range cannot be changed to 50% LEL until the SPAN value is decreased.
- An alarm setpoint cannot be set outside the range of the instrument. Therefore, the alarms must be decreased if they were previously changed from the original settings of 10%, 20%, and 30% LEL.
 - If the above two statements are true, the range can be decreased to the desired full-scale limit.
- The Ultima X Series Gas Monitor range value is now changed to the selected limit.

Procedure 4 Setting the Gas Table for the Ultima XIR Sensor

This feature changes the response curve to the specific target gas selected. After completion of Procedure 4, the appropriate span value listed in TABLE 2-2 must also be reset in accordance with Procedure 2.

1. Press the SEND button.
 - The display prompts: **SEND?**
2. Press the SPAN button.
 - The display prompts: **Span Option ±.**
3. Press the + or - button until the display prompts: **UltimaX GasTble.**
4. Press the ENTER button.
 - The display prompts: **GasTble ###.**
5. Using the NUMBER buttons, enter the desired value (leading zeros are required).

Gas Table Selection	
001	Methane
002	Propane
003	Ethane
004	Butane
005	Pentane
006	Hexane
007	Cyclopentane
008	Ethylene

6. After the value is entered, aim the controller at the sensor and press the ENTER button.
 - The Ultima XIR Series Gas Monitor will reset after receiving a valid gas table value (otherwise, the Ultima X Monitor will indicate that changing the gas table value has been unsuccessful).
 - The Ultima XIR Gas Monitor gas table value is now changed to the selected value.

Procedure 5. Setting the Three Ultima Gas Monitor Alarm Setpoint Values

The Ultima Gas Monitor has three alarm levels. The relay module can be connected directly to the Ultima Gas Monitor to provide three levels of relays and a normally energized trouble relay. The three levels of alarm will also be displayed on the Ultima Gas Monitor LCD display even if an Ultima Gas Monitor relay module is not used.

- Alarm #1 must be set at a lower or equal value than Alarm #2
- Alarm #2 must be set lower or equal than Alarm #3
- On the oxygen unit:
 - Alarms #1 and #2 are negative or downward acting
 - Alarm #3 is positive or upward acting
 - Alarms #1, #2 and #3 can be set to any value; they are independent of one another.

To set the three levels of alarm:

1. Press the SEND button.
 - The display prompts: **SEND?**
2. Press the ALARM button.
 - The display prompts: **0=SetPt 1=OnOff**
3. To set the alarm values, press the 0 button.
 - The display prompts: **Alm Gas Type ±.**
4. Press the + or - button to scroll through the available list:
NOTE: If your gas type or range is not shown on the Controller display, you may use the custom range option on the menu.
5. When the selection matching your sensor type is found, press the ENTER button. (Invalid entries are ignored.)

- The display prompts: **Alm Set Point #**.
6. Using the NUMBER buttons, enter the desired alarm setpoint 1, 2 or 3; then, press the ENTER button. (Invalid entries are ignored.)
 - The display prompts: **SetPVal ###**

NOTE: If the custom range option was selected, a decimal point may be implied, since this range can be used for decimal point and non-decimal point Ultima units. When sending a value to an Ultima unit that indicates a decimal point, enter the data assuming an implied decimal point (e.g., "009" is interpreted as "00.9").
 7. Enter the desired value in an appropriate range for the gas type used. (Leading zeros are required.)
 - The DEL button can be used to delete number entries before the ENTER button is pressed
 - The Ultima Gas Monitor will show the new alarm setpoint value and the status of that setpoint [enabled (ON) or disabled (OFF)].

NOTE: The combustible alarm setpoint value cannot be set greater than 60% LEL.
 8. Aim the controller at the sensor and press the ENTER button.
 - If the alarm setpoint value is greater than the full scale gas concentration value, the Controller will not change the setpoint value; re-enter an alarm setpoint value lower than or equal to the full scale gas concentration value
 - Repeat this procedure for each alarm level.

Setting the Three Ultima X Series Gas Monitor Alarm Setpoint Values

The Ultima X Series Gas Monitor has three alarm levels. The relay option provides:

- three levels of relays and
- a normally-energized trouble relay.

The three levels of alarm display on the Ultima X Series LCD display even if the relay option is not installed.

To set the three levels of alarm:

1. Press the SEND button.
 - The display prompts: **SEND?**

2. Press the ALARM button.
 - The display prompts: **0=SetPt 1=OnOff**.
3. To set the alarm values, press the 0 button.
 - The display prompts: **Alm Set Point #**.
4. Using the NUMBER buttons, enter the desired alarm setpoint 1, 2 or 3; then press the ENTER button. (Invalid entries are ignored.)
 - The display prompts: **SetPVal ####.##**.
5. Using the NUMBER buttons, enter the desired value (ATM style, lagging zeros are required).
 - The DEL button can be used to delete number entries before the ENTER button is pressed.
 - The Ultima X Series Gas Monitor will show the new alarm setpoint value and the status of the setpoint:
 - enabled (LATCH/UNLATCH, INCR/DECR, ENER/DENERG) or
 - disabled (OFF).

NOTE: The combustible alarm setpoint value cannot be set greater than 60% LEL.
6. Aim the controller at the sensor and press the ENTER button.
 - If the alarm setpoint value is greater than the full scale gas concentration value, the controller will not change the setpoint value; re-enter an alarm setpoint value lower than or equal to the full scale gas concentration value.
 - Repeat this procedure for each alarm level.

Enabling/Disabling and Setting the Mode of the Three Ultima Alarm Setpoints

1. Press the SEND button.
 - The display prompts: **SEND?**
2. Press the ALARM button.
 - The display prompts: **0=SetPt 1=OnOff**.
3. Press the 1 button.
 - The display prompts: **Alm Gas Type ±**.
4. Press either the + or - button to scroll through the list:
5. When the selection matching your sensor type is found, press the ENTER button.

- The display prompts: **Alm Set Point #**.
6. Using the NUMBER buttons, enter the desired alarm setpoint 1, 2 or 3; then, press the ENTER button. (Invalid entries are ignored.)
 - The DEL button can be used to delete number entries before the ENTER button is pressed
 - The display prompts: **AlmSPnt 1=E 0=D**.
 7. To **Disable** the chosen setpoint, aim the Controller at the sensor and press the 0 button.
 - The Ultima Gas Monitor will show both the status (**OFF**) and the alarm setpoint value.
 8. To **Enable** the chosen setpoint, press the 1 button
 - The display prompts: **Latched 0=N 1=Y**.Aim the Controller at the sensor:
 - a. Press the 0 button to enable the alarm in unlatched mode
or
 - b. Press the 1 button to enable the alarm in latched mode.
 - The Ultima Gas Monitor will show both the status (**on U** if unlatched or **on L** if latched) and the alarm setpoint value.

Enabling/Disabling and setting the Mode of the Three Ultima X Series Alarm Setpoints

1. Press the SEND button.
 - The display prompts: **SEND?**.
2. Press the ALARM button.
 - The display prompts: **0=SetPt 1=OnOFF**.
3. Press the 1 button.
 - The display prompts: **Alm Set Point #**.
4. Using the NUMBER buttons, enter the desired alarm setpoint 1, 2, or 3; then, press the ENTER button. (Invalid entries are ignored.)
 - The DEL button can be used to delete number entries before the ENTER button is pressed.
 - The display prompts: **AlmSPnt 1=E 0=D**.
5. To Disable the chosen setpoint, aim the Controller at the sensor and press the 0 button.

- The Ultima X Series Gas Monitor will show both the status (OFF) and the alarm setpoint value.
6. To enable the chosen setpoint, press the 1 button.
 - The display prompts: **Latched 0=N 1=Y**.
 7. To set the alarm as a latching alarm, press the 1 button; to set the alarm as unlatching, press the 0 button. (Invalid entries are ignored.)
 - The display prompts: **0=DOWN 1=UP**.
 8. To set the alarm as a downward acting alarm, press the 0 button; to set the alarm as an upward acting alarm, press the 1 button. (Invalid entries will be ignored.)
 - The display prompts: **0=NONEN 1=ENGZD**.
 9. Aim the Controller at the sensor.
 - a. Press the 0 button to enable the alarm as a non-energized alarm.
 - b. Press the 1 button to enable the alarm as an energized alarm.
 - The Ultima X Series Gas Monitor will show the alarm setpoint value and the status:
 - LATCH/UNLATCH, INCR/DECR, ENER/DENERG.

Procedure 6. Setting the Current Time

The Ultima Gas Monitor is factory-set to Eastern Standard Time. To change it in the Controller and in the Ultima Gas Monitor:

1. Press and hold the TIME button.
 - The display prompts: **##:##**
2. Using the number keys, enter the correct time in the military format (e.g., 4:00 P.M. = 16:00). (Leading zeros required.)
3. Press the ENTER button.

To update the Ultima Gas Monitor internal clock:

1. Press the SEND button.
2. Aim the Controller at the sensor and press the TIME button.

NOTE: Time and date are updated with this command.

 - The Ultima Gas Monitor will display the current time and date for five seconds.

Procedure 7. Setting the Current Date

The Ultima Gas Monitor is factory-set to the current date. To change it in the Controller and in the Ultima Gas Monitor:

1. Press and hold the DATE button to enter the correct date.
 - The display prompts: **MM-DD-YYYY**
2. Use number keys to enter correct date (leading zeros required):
 - MM = Months
 - DD = Date
 - YYYY = Year
3. Press the ENTER button.

To update the Ultima Gas Monitor internal date

1. Press the SEND button.
2. Aim the Controller at the sensor and press the DATE button.

NOTE: Time *and* date are updated with this command.

 - The Ultima Gas Monitor will display the current time and date for five seconds.

Procedure 8. Enabling/Disabling Ultima Gas Monitor Calibration Output Signal

The Ultima Gas Monitor is shipped with the calibration output signal disabled. This means that the output signal will track the gas concentration value during the calibration process. In some applications, it may be desirable to enable or lock the calibration output signal to a pre-determined output value to prevent activation of alarm devices. For frequency and MUX models, this value is 12 KHZ, which is recognized by MSA Model 6000 instruments as a calibration signal. 4 to 20 milliamp output signal models are locked to 3.75 mA during this process (however, oxygen models lock at 21 mA).

NOTE: See Procedure 15, Setting the Alert Option on an Ultima X Series Sensor, for details on oxygen sensors calibration signals.

For the MSA Model 5000 and Toxgard instruments, manually place the instrument in the Calibration Mode.

To enable or disable the calibration output signal:

1. Press the SEND button.
 - The display prompts **SEND?**

2. Press the CAL button.
 - The display prompts: **Sel Cal Action ±.**
3. Press either the + or - button and scroll to the CalSIG Enable display message.
4. Press the ENTER button.
 - The display prompts: **En Cal 0=N 1=Y.**
5. To enable calibration signal output, aim the controller at the sensor and press the 1 button.
 - The command is sent immediately
 - The Ultima Gas Monitor will flash: **Sig ON**
 - The Ultima X Series Gas Monitor will display: **CAL SIG ON.**
6. To disable the calibration signal, aim the controller at the sensor and press the 0 button.
 - The command is sent immediately
 - The Ultima Gas Monitor will flash **Sig OFF**
 - The Ultima X Series Gas Monitor will display: **CAL SIG OFF.**

Procedure 9. Setting the Number of Days Between Ultima Gas Monitor Auto-calibration Periods

With the use of the Ultima Gas Monitor auto-calibration module, the Ultima Gas Monitor is capable of automatically applying zero and span gas to itself. This provides a complete calibration of the sensor without operator intervention. If the Ultima Gas Monitor auto-calibration module is connected, the Ultima Gas Monitor must be programmed to calibrate itself between 1- to 128-day intervals.

1. Press the SEND button.
 - The display prompts: **Send?**
2. Press the CAL button.
 - The display prompts: **Sel Cal Action ±.**
3. Press either the + or - button and scroll to the **DaysPerAutoCal** display message.
4. Press the ENTER button.
 - The display prompts: **CalTerm ### dy**

5. Enter the three-digit period desired (from 1 day to 128 days). (Leading zeros are required.)
6. Aim the controller at the sensor and press the ENTER button.
 - The Ultima Gas Monitor will show the number of days between auto-calibrations for five seconds
 - The Ultima Gas Monitor is now programmed to auto-calibrate at the desired interval.

Setting the Time that Ultima Gas Monitor Auto-calibration is to begin

1. Press the SEND button.
 - The display prompts **SEND?**
2. Press the CAL button.
 - The display prompts: **Sel Cal Action ±.**
3. Press either the **+** or **-** button and scroll to the **StartHr of Cal** display message.
4. Press the ENTER button.
 - The display prompts: **CalHour HH.**
5. Enter the two-digit hour desired (from 0 to 23 hours YPM = 16 hours). (Leading zero is required.)
6. Aim the controller at the sensor and press the ENTER button.
 - The Ultima Gas Monitor will display the hour selected
 - The Ultima Gas Monitor is now programmed to auto-calibrate at the desired time.

Procedure 10. Setting the Date of the Next Scheduled Ultima Gas Monitor Calibration

To disable the auto-calibration of the Ultima Gas Monitor, set the date of the next calibration to 12/31/94.

1. Press the SEND button.
 - The display prompts: **SEND?**
2. Press the CAL button.
 - the display prompts: **Sel Cal Action ±.**
3. Press either the **+** or **-** button and scroll to the NextCal Date display message.
4. Press the ENTER button.

- the display prompts: **MM-DD YYYY**.
5. Enter a valid eight-digit date (month-day-year).
 6. Aim the controller at the sensor and press the ENTER button. (Leading zeros are required.)
 - The Ultima Gas Monitor will display the future date auto-calibration will start
 - The Ultima Gas Monitor is now programmed to auto-calibrate on the desired date.

Procedure 11. Changing the MUX Address

1. Viewing the current Mux Address, aim the Controller at the Ultima Gas Monitor.
2. Press the ADDRESS button.
 - The current address of the sensor is displayed.

NOTE: Additional pressing of the ADDRESS button will increment the address.

To Change the Address

1. Press the SEND button.
2. Press the ADDRESS button.
3. Enter the number of the address to be set.
4. Aim the Controller at the Ultima Gas Monitor and press the ENTER button.
 - The Ultima Gas Monitor will display the new address for five seconds.

Procedure 12. Viewing the Previous Successful Calibration Date

1. Press the SEND button.
 - The display prompts: **SEND?**
2. Press the DISPLAY button.
 - The display prompts: **SeL Dsp Item ±**
3. Press the + or - button to scroll and find: **Prev. Cal Date**.
4. Aim the Controller at the Ultima Gas Monitor and press the ENTER button.
 - The Ultima Gas Monitor will display the last previously successful calibration date.

Procedure 13. Calibrating/Checking the 4-20 mA Ultima X Series Outputs

1. Press the SEND button.
 - The display prompts **SEND?**.
2. Press the CAL button.
 - The display prompts: **Sel Cal Action ±**.
3. Press the **+** or **-** button until the display prompts: **4-20**; then, press the ENTER button.
 - The display prompts: **0=4mA 1=20mA**.
4. To Calibrate/Check the 4 mA output press the 0 button, to Calibrate/Check the 20 mA output press the 1 button.
 - The display prompts: **0 = Check 1=Adjust**.
5. To CHECK, aim the controller at the sensor and press the ENTER button.
 - The display toggles between gas value and **CAL**.
 - The 4 - 20 mA output will be set as selected (4 mA or 20 mA).
 - The 4 - 20 mA output stays in a CAL output for 1 minute.
6. To ADJUST, press the 1 button.
 - The display prompts: **+=INC -=DEC**.
7. To increase the current 4 mA or 20 mA setpoint, aim the controller at the sensor and press the **+** button. To decrease the current 4 mA or 20 mA setpoint, press the **-** button.
 - The display toggles between gas value and **CAL**.
 - The adjusted 4 - 20 mA output will be set to the adjusted 4 mA or 20 mA output level.
 - The 4 - 20 mA output stays in a CAL output for 1 minute.
8. Repeat the procedure to continue to adjust the output.

NOTE: Adjusting the 4 mA output changes the 20 mA setting. Always re-adjust the 20 mA output after adjusting the 4 mA output. Adjusting the 20 mA output will not change the 4 mA output setting.

Procedure 14. Resetting the Ultima X Series Monitors

1. Press the SEND button.
 - The display prompts: **SEND?**.

2. Press the SEND button.
 - The display prompts: **0=RstDt 1=RstSn.**
3. To reset the datasheets, press the 0 button.
 - a. The display prompts: **RstData 0=N 1=Y.**

NOTE: Resetting the datasheets loads the factory defaults for the attached sensor. The user must reconfigure the instrument for their desired settings. A successful calibration must also be performed after resetting the datasheets.

To reset the instrument, press the 1 button.

- a. The display prompts: **RstSnsr 0=N 1=Y.**
4. Aim the Controller at the sensor and press the 0 button to cancel, or press the 1 button to reset.

Procedure 15. Setting the Alert Option on an Ultima X Series Sensor

The Alert option allows the operator to set the Ultima X unit to operate as shown in TABLE 3-2.

Table 3-2. Alert Operation Settings		
	ALERT OPTION	
	ON	OFF
CALIBRATION	Alert relay de-energized	Alert relay energized
POWER ON RESET (countdown)	Alert relay de-energized	Alert relay energized
4-20 CAL mA (Oxygen)	3.75 mA	21 mA
4-20 POWER ON RESET mA (Oxygen)	3.75 mA	21 mA

1. Press the SEND button.
 - The display prompts: **SEND?.**
2. Press the CAL button.
 - The display prompts: **Sel Cal Action ±.**
3. Press the + or - button until the display prompts: **Alert Option.**
4. Press the ENTER button.

- The display prompts: **AlrtOpt 0=N 1=Y**.
5. Aim the Controller at the Sensor and press either the 0 or 1 button.
 - The Ultima X Series Gas Monitor Alert Option is now changed to the selected operation.

Procedure 16. Setting the Sensor Swap Delay on an Ultima X Sensor

- The Ultima X Series Gas Monitor is shipped with the Sensor Swap Delay enabled. This means that the 4-20 mA output signal and the FAULT relay will hold off a fault indication for 60 seconds after the sensor missing indication is displayed on the instrument. This setting allows the operator to exchange sensor modules without a FAULT indication.
- This feature can be disabled to provide an immediate FAULT error condition. To change it, use the Controller to perform the following steps:
 1. Press the SEND button.
 - The display prompts: **SEND?**
 2. Press the CAL button.
 - The display prompts: **Sel Cal Action ±**.
 3. Press the + or - button until the display prompts: **Sensor SwapDly**.
 4. Press the ENTER button.
 - The display prompts: **SwapDly 0=N 1=Y**.
 5. Aim the controller at the sensor and press either the 0 or 1 button.

Programming the Controller

The Controller can be programmed to set up or group or repeat all of your Ultima Gas Monitors in one particular way. There are nine possible programs (1 through 9). However, program #9 is solely used to link or combine five of the remaining eight programs. These programs are useful to eliminate duplicate keystrokes or to ensure the same configuration at each mounting site.

Removing Existing Programs

It is good practice to remove the existing programs before attempting to initiate a new one.

1. Press and hold the 0 button.
 - The display prompts: **Clr Prgs 0=N 1=Y**
2. Press 1 to remove all programs.

Adding a New Program

There are eight programs available, 1 through 8. Each program will accept one Ultima Gas Monitor command.

To enter a new program:

1. Press and hold the PROGRAM button until the display prompt reads: **ENTER PRGM #**.
2. Enter the program number (1 through 8).
NOTE: A dual beep tone is heard for each entry during the Calibrator programming mode.
3. Press the ENTER button.
4. Enter the keystrokes of the single Ultima Gas Monitor function desired. When all of the keystrokes are entered, the Controller will save them and display: **SAVING---** for three seconds.
5. Repeat steps 1 through 4, using a different program number to program additional Ultima Gas Monitor functions.

Linking or Combining Programs

It is often necessary to send multiple programs to the Ultima Gas Monitor. Program #9 allows the linking or combining of five of the eight programs.

To Link Programs

1. Press and hold the PROGRAM button until the display prompts: **ENTER PRGM #**.
2. Enter program #9 by pressing the 9 key.
 - A dual beep tone sounds.
3. Press the ENTER button.
 - The display will prompt: **LINK #**.
4. Enter the program numbers (1 through 8) to be combined or linked.
 - Only five programs can be linked.
5. Press the ENTER button.
 - The Controller will save this sequence.

NOTE: Empty programs can be linked but will not be sent.

To Use Programs 1 through 8

1. Press the PROGRAM button.
 - The display will prompt: **PROGRAM #**.
2. Enter the desired program number (1 through 8).
3. Aim the Controller at the Ultima Gas Monitor and press the ENTER button.
 - The Ultima Gas Monitor will respond immediately.

To use Program #9

1. Press PROGRAM key.
2. Enter number 9.
3. Aim the Controller at the Ultima Gas Monitor and press the ENTER button.
 - The Ultima Gas Monitor will respond to the first program.
4. Press the 0 key to resend the first program or press 1 to send the next programs linked; if there are no other programs linked, press the 1 key to end.

To use Program #0

Program #0 is used to send the previous command. Resending the last command is useful if it involved a number of keystrokes. Program #0 will resend all of the commands **except for the following:**

- ZERO
- CAL
- ADDRESS
- INITIAL CAL OR INITIAL CALIBRATION
- SET TIME on the Calibrator
- SET DATE on the Calibrator

To resend any command **except for those listed above:**

1. Press the PROGRAM key.
2. Press the "0" key. (This is the **number** zero key, **not** the key labeled ZERO.)
3. Aim the Controller at the Ultima Gas Monitor and press ENTER.

If the last command is one of the three listed above, it will not send that command; instead, the Controller will send the preceding command.

Section 4 Maintenance

WARNING

The Ultima Controller and Ultima Calibrator are rated as intrinsically safe for Class I, Division 1, Groups A, B, C and D areas during normal operation. All maintenance procedures must be performed in a non-hazardous area. Failure to comply with this warning can result in serious personal injury or death.

Batteries

- The Ultima Controller is approved for use with two Duracell MN1500 "AA" Alkaline cells.
- The Ultima Calibrator is approved for use with either two Duracell MN2400 or two Eveready E92 "AAA" Alkaline cells.

Determining a Low Battery Condition on the Ultima Controller

To Determine if Battery Replacement is Necessary

1. Turn the controller unit ON.
 - After the unit completes its initialization, the display shows **ID CODE**, **READY** or **ready**.
2. If the display shows the **ID CODE** message, enter the correct code (see "Using the ID CODE Feature") to reach the ready prompt.
3. The **READY** display is the low battery indicator:
 - If **READY** appears (upper case letters), the batteries are OK
 - If **ready** appears (lower case letters), the batteries are weak and must be replaced.

Replacing the Batteries

To Install New Batteries in the Ultima Controller

1. Turn OFF the Ultima Controller.
2. Remove the four screws from the rear of the case and carefully pull the rear cover away from the unit.

3. Remove the two weak batteries from the battery holder and dispose of properly.
4. Observing the proper polarity as shown on the plastic holder, install two new batteries in the holder.
5. If either end-cover was removed during removal of the back cover, reinsert it in its original location. (The dark IR lens must be at the top.)
6. If the dark IR lens at the top of the unit is dirty, clean with soapy water and dry before reinstalling it.
 - The lens must be clean for proper operation.
7. With both lenses in place, replace the rear cover and re-install the four case screws.
8. Turn unit ON to verify operation.

NOTE: Changing the controller batteries does not effect the internal real time clock or stored programs; therefore, the time and date values remain as previously set.

Determining a Low Battery Condition on the Ultima Calibrator

1. Turn unit ON by pressing any button.
 - **Low battery** results in a double beep for each key press
 - **Normal battery** results in a single beep for each key press.

To Install New Batteries in the Ultima Calibrator

1. Turn OFF the Calibrator and remove the four screws from the rear of the Ultima Calibrator unit.
2. Remove the two AAA batteries from their holders.
3. Observing the proper polarity as shown on the plastic holder, install two new batteries in the holder.
4. Re-install the back cover of the Calibrator.
5. Press any Calibrator button and listen for beep to ensure unit is operational.

Service

There are no internal adjustments to be made in the Ultima Controller. For any service work, return to the unit to MSA:

**MSA Instrument Division
Repair and Service
1000 Cranberry Woods Drive
Cranberry Township, PA 16066-5207**

or call toll-free: 1-800-MSA-INST.

WARNING

Repair or alteration of these units, beyond the scope of these maintenance instructions or by anyone other than authorized MSA service personnel, could cause the products to fail to perform as designed and persons who rely on these products for their safety could sustain serious personal injury or death.

Troubleshooting Guidelines		
PROBLEM	POSSIBLE CAUSE	POSSIBLE SOLUTION
CONTROLLER OR CALIBRATOR INOPERATIVE	Dead batteries	Replace batteries
	Dirty lens	Clean the dark red lens on the front end of the Controller or Calibrator
	Too much ambient light	Reduce the ambient light to the Ultima or Ultima X Series Gas Monitor by creating a light shield